

**Art.Nr. 00.665.18.1-A02 | Towing Eyes | Flange**

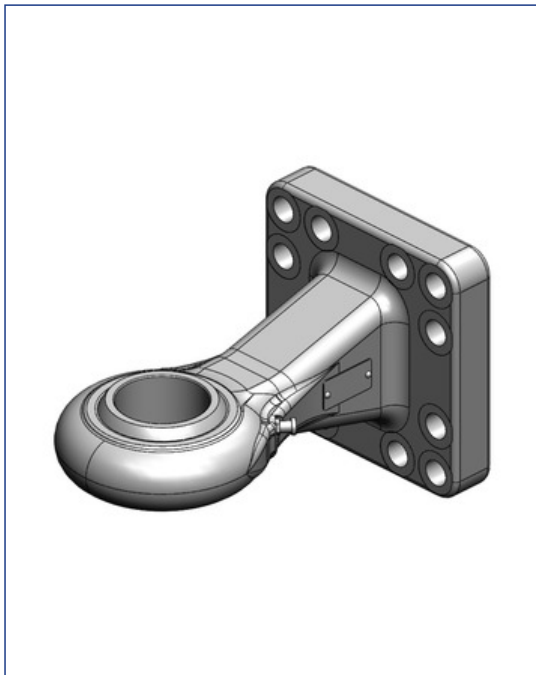

Ball Joint Towing Eye Cat. 5 DØ71mm





Alternative color

00.665.18.1-A02 (Black )

Technical Values\*

**Flange Hole Pattern (mm):** 160x160 | **Thread:** M20 | **Hole Pattern Holes:** 12 |  
**Flange Alignment:** Vertical | **Working Length (mm):** 246 | **Max. Permissible D-Value (kN):** 120,2 | **Max. Permissible Vertical Load (kg):** 3000

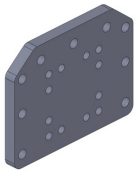
**Attachments**

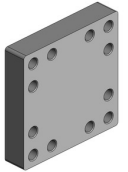
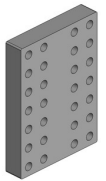
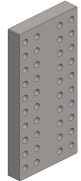
|  |   |  |   |  |
|--|---|--|---|--|
| <p><b>Art.Nr. 00.950.30.0</b><br/>Screw Sets</p>      | <p><b>Art.Nr. 00.645.17.9</b><br/>Screw-On Plates</p>  | <p><b>Art.Nr. 00.645.310.0</b><br/>Screw-On Plates</p>  | <p><b>Art.Nr. 00.645.60.0</b><br/>Screw-On Plates</p>  | <p><b>Art.Nr. 00.645.13.0</b><br/>Weld-On Plates</p>  |
| <p><b>Art.Nr. 00.645.14.0</b><br/>Weld-On Plates</p>  | <p><b>Art.Nr. 00.645.140.0</b><br/>Weld-On Plates</p>  |  |   |  |