

**Art.Nr. 00.652.171.1-A02 | Towing Eyes | Flange**

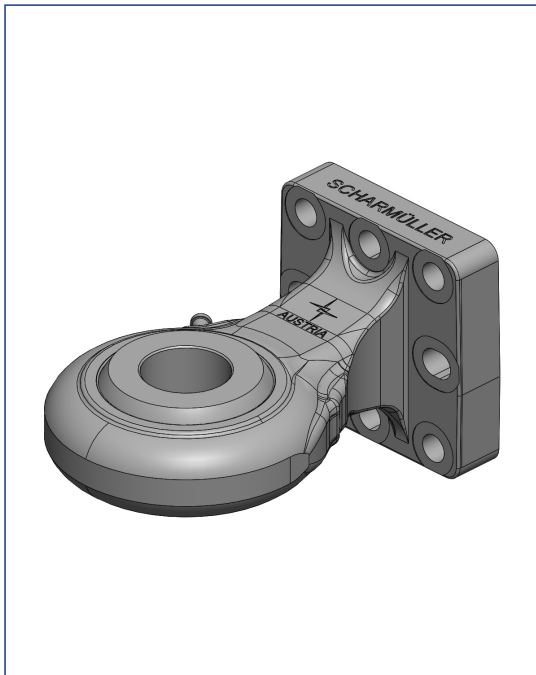

Ball Joint Towing Eye Cat. 4 DØ51mm

**Alternative color**

00.652.171.1-A02 (Black )

**Technical Values\***

**Flange Hole Pattern (mm):** 110x100 | **Thread:** M16 | **Hole Pattern Holes:** 8 |  
**Flange Alignment:** Vertical | **Working Length (mm):** 173 | **Max. Permissible D-Value (kN):** 89,3 | **Max. Permissible Vertical Load (kg):** 3000

**Attachments**

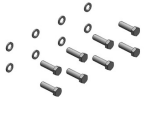
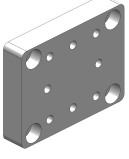
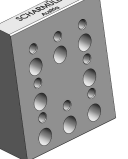
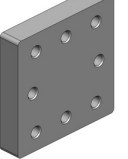
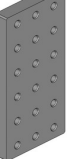
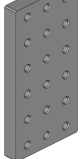
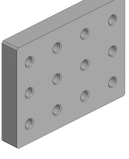
<p><b>Art.Nr. 00.950.06.0</b> Screw Sets</p> 	<p><b>Art.Nr. 00.645.22.0</b> Screw-On Plates</p> 	<p><b>Art.Nr. 00.645.29.0</b> Screw-On Plates</p> 	<p><b>Art.Nr. 00.645.04.0</b> Weld-On Plates</p> 	<p><b>Art.Nr. 00.645.08.0</b> Weld-On Plates</p> 
<p><b>Art.Nr. 00.645.080.0</b> Weld-On Plates</p> 	<p><b>Art.Nr. 00.645.081.0</b> Weld-On Plates</p> 	<p><b>Art.Nr. 00.645.083.0</b> Weld-On Plates</p> 