

Art.Nr. 00.650.90.1-A02 | Towing Eyes | Flange

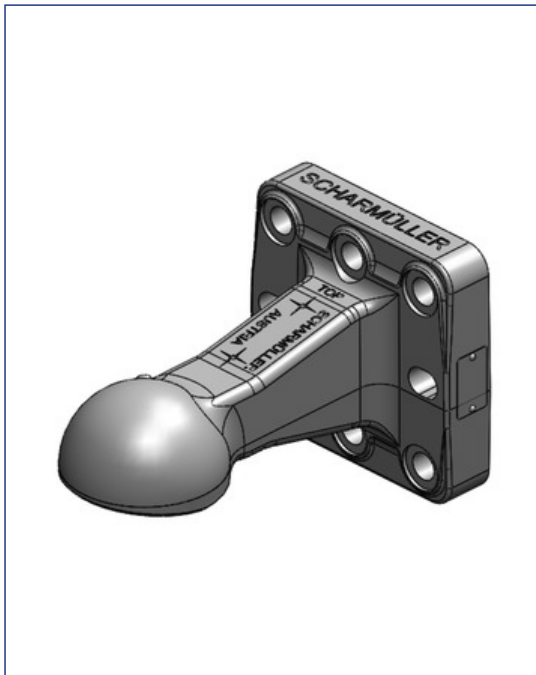

K80® Towing Eye Ball Coupling System

with Type Plate for Homologation after Land and Forestry VO_208_2015



Alternative color

00.650.90.1-A02 (Black)

Technical Values*

Flange Hole Pattern (mm): 145x145 | **Thread:** M20 | **Hole Pattern Holes:** 8 |
Flange Alignment: Vertical | **Working Length (mm):** 252 | **Max. Permissible D-Value (kN):** 120 | **Max. Permissible Vertical Load (kg):** 4000

Attachments

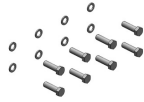
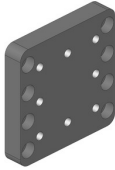
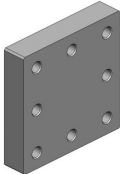
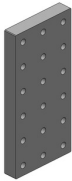
<p>Art.Nr. 10.731.001.0 Anti-Theft Locks</p> 	<p>Art.Nr. 10.333.3280.0 Wear Gauge</p> 	<p>Art.Nr. 00.950.05.0 Screw Sets</p> 	<p>Art.Nr. 00.645.05.0 Screw-On Plates</p> 	<p>Art.Nr. 00.645.01.0 Weld-On Plates</p> 
<p>Art.Nr. 00.645.09.0 Weld-On Plates</p> 	<p>Art.Nr. 00.645.27.0 Weld-On Plates</p> 